

KLIPPEARK BILLEDLOTTERI

1

2

3

4

5

6

7

8

9

KLIPPEARK BILLEDLOTTERI

10

11

12

13

14

15

16

17

18

KLIPPEARK BILLEDLOTTERI

19

20

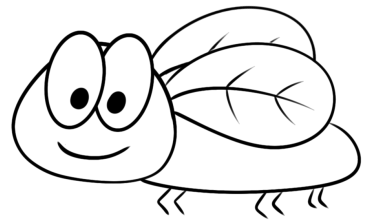
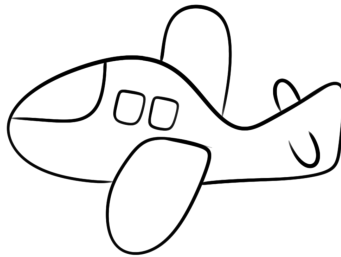
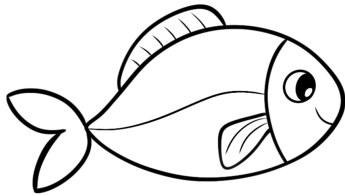
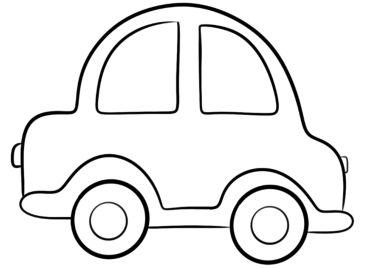

BILLEDLOTTERI - TAL

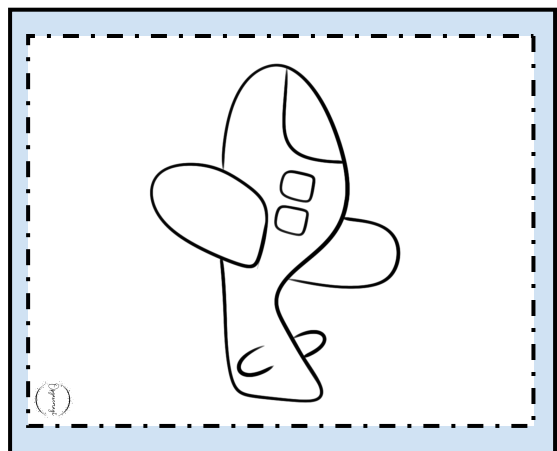
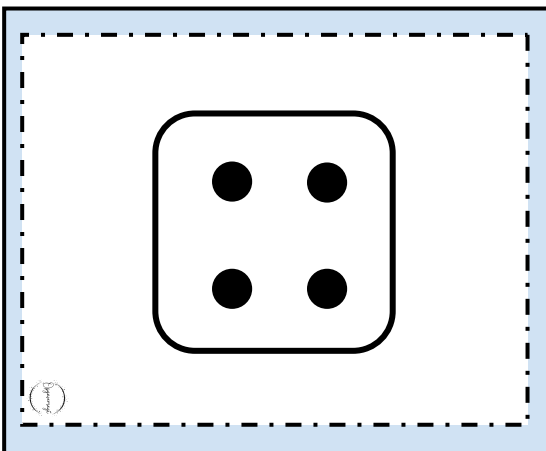
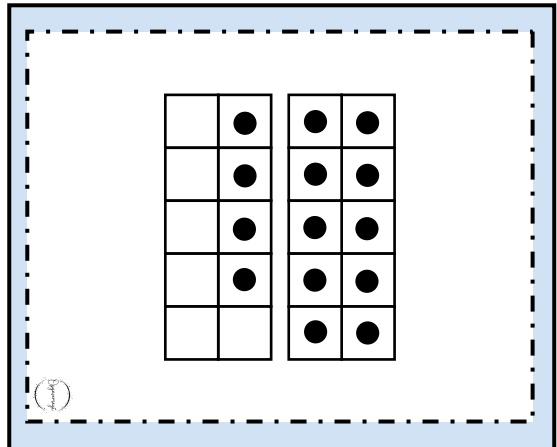
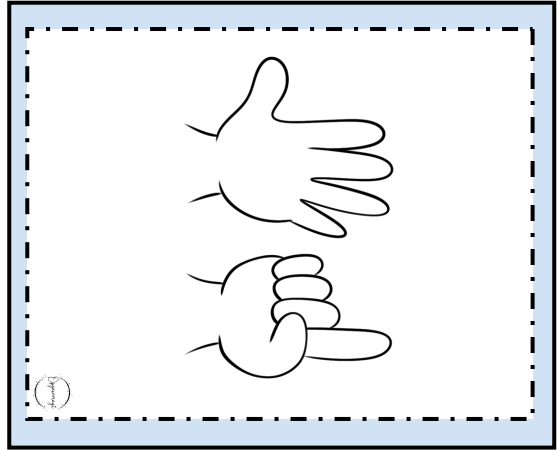
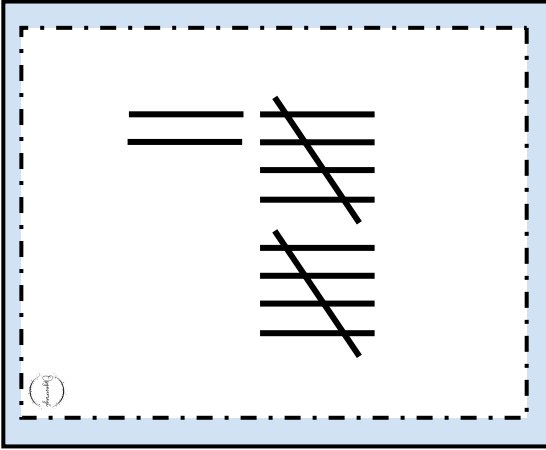

BILLEDLOTTERI - TAL

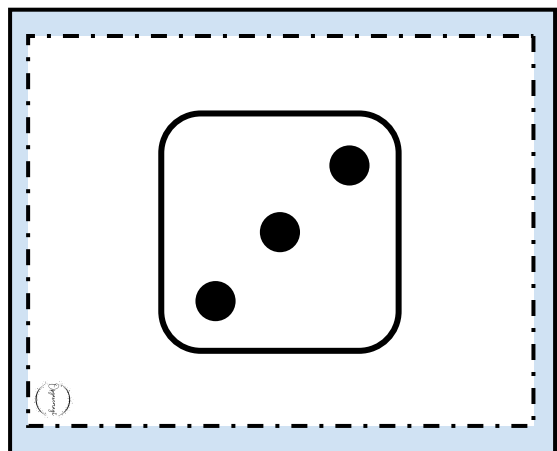
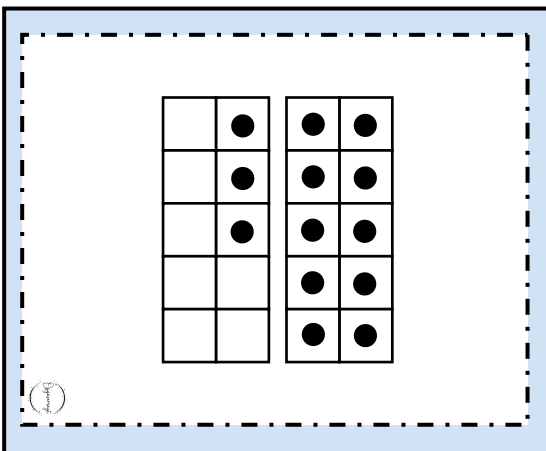
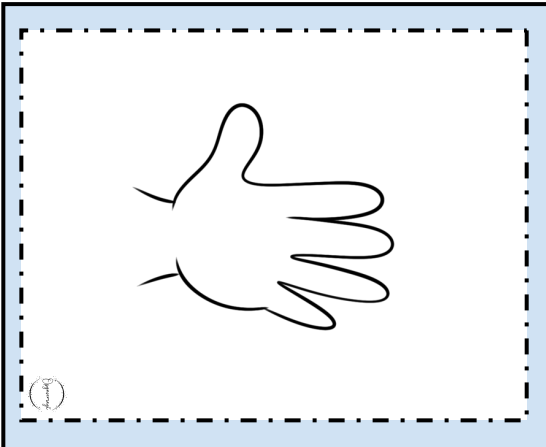
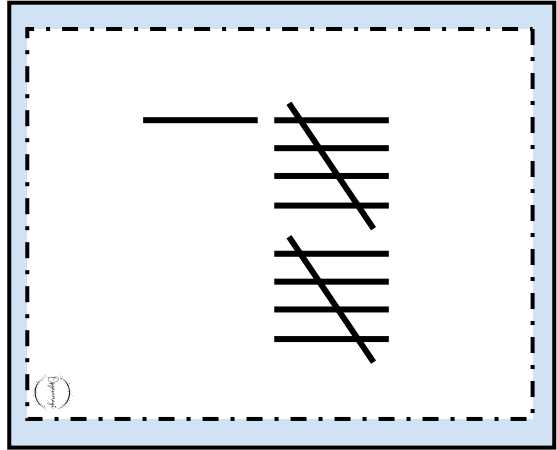
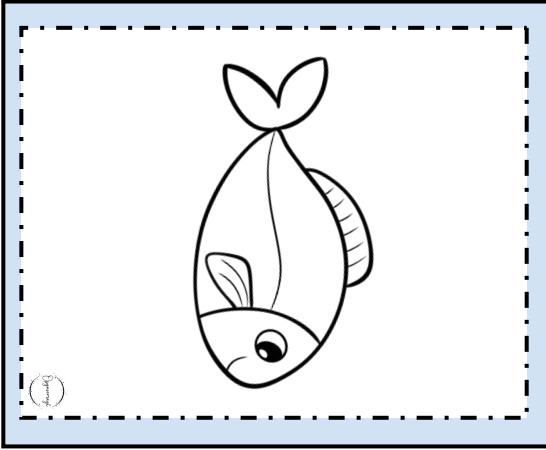

BILLEDLITTERI - TAL

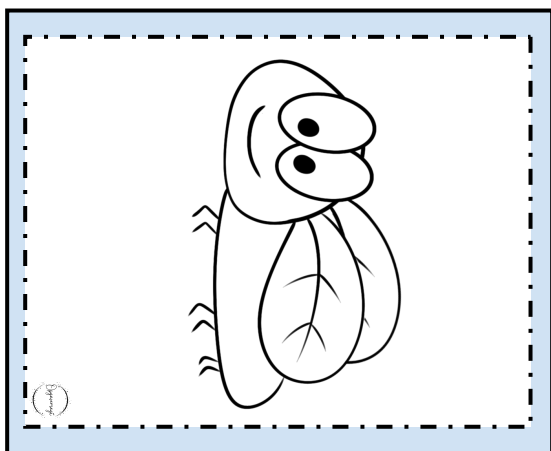
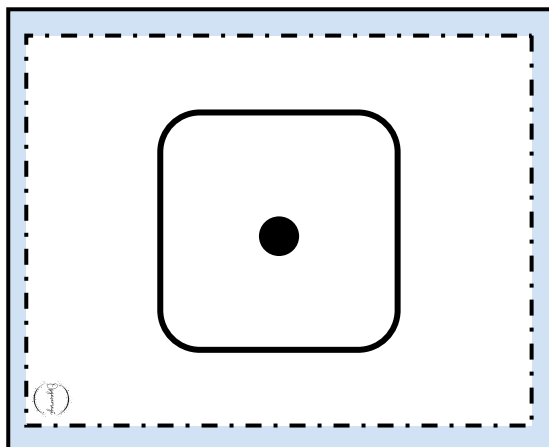
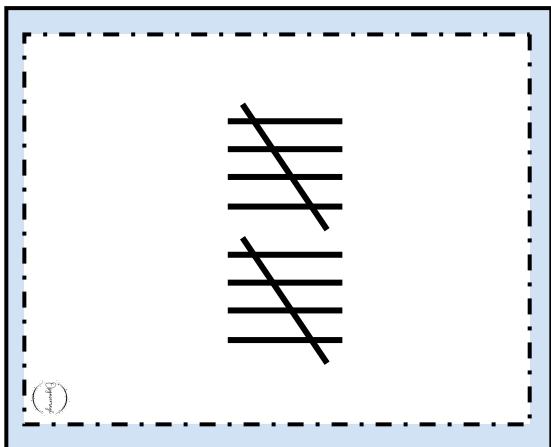
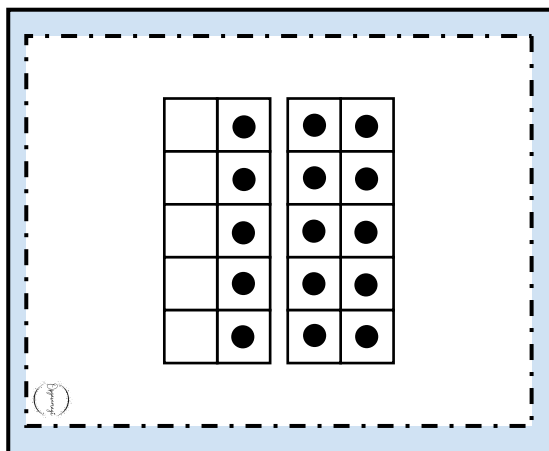
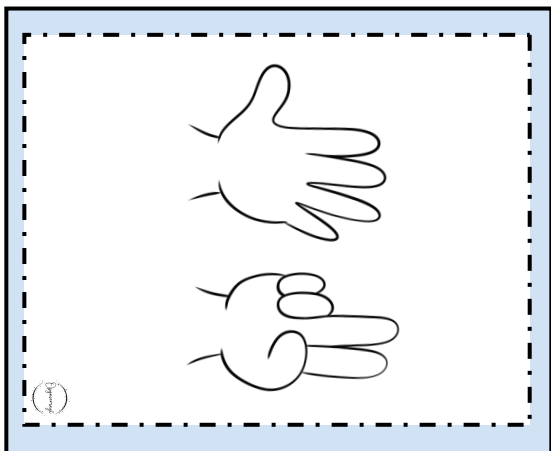

BILLEDLOTTERI - TAL

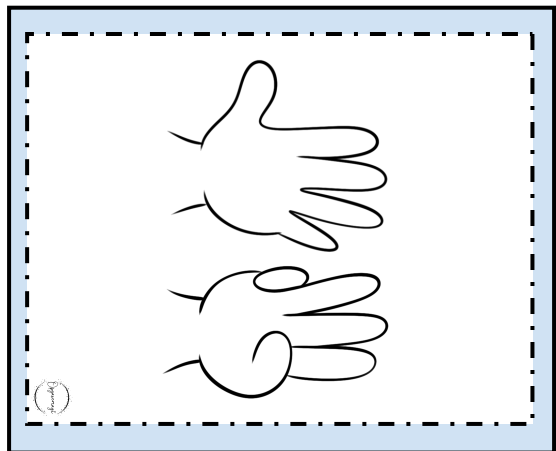
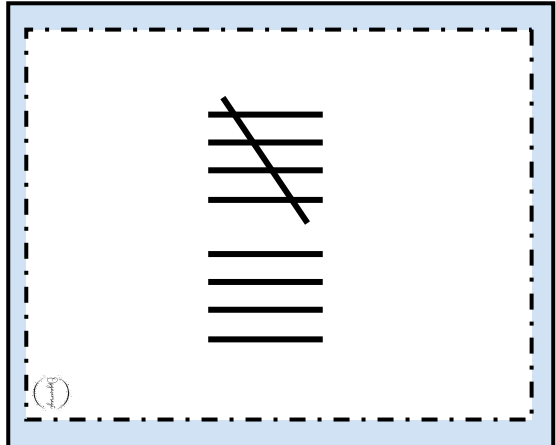
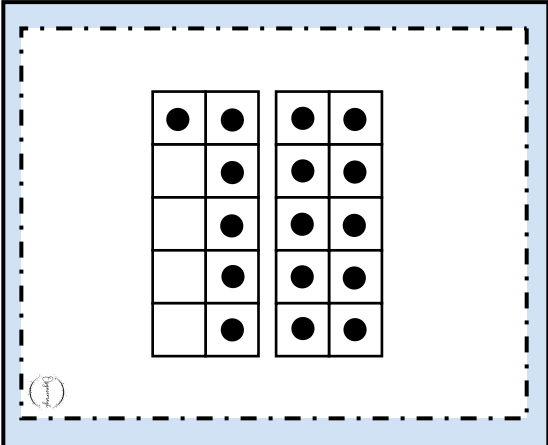
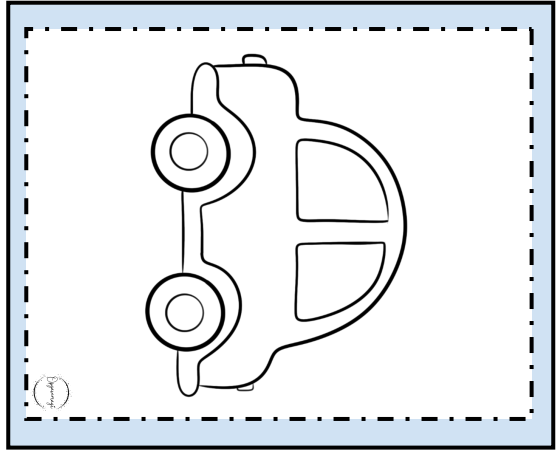
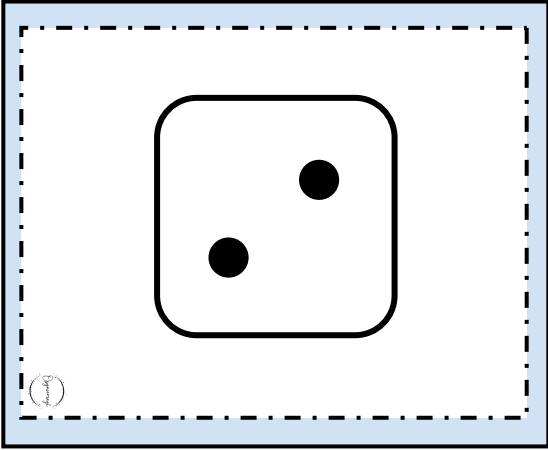

Kæmpe tak!

Tak fordi du hentede mit materiale, det betyder mere end du tror.

På min hjemmeside tilbyder jeg et bredt udvalg af undervisningsmaterialer og inspiration til børn i alderen 3 – 8 år. På opgavemagi kan du som, forældre, pædagog og lærer, hente materiale og få inspiration til sjove aktiviteter, helt gratis.

Jeg håber at det bliver til stor glæde for dig og dine børn, uanset om det er til privat brug eller til undervisning.

Materialet er udarbejdet af Opgavemagi.dk.

Hvis du har spørgsmål eller kommentarer er du velkommen til at kontakte mig på opgavemagi@gmail.com

Al kopiering, analogt og digitalt, af dette materiale eller dele derafer tilladt i henhold til undervisningsinstitutionens aftale med Copydan Tekst & Node. Kopiering, der går ud over begrænsningsreglerne i aftalen med Copydan Tekst & Node, kan alene finde sted efter forudgående aftale med licensgiver.

N Å R L Æ R I N G B L I V E R M A G I S K .

Tekst og illustrationer af Opgavemagi.dk



De bedste hilsner

Trine

Opgavemagi

Opgavemagi